

MC33465

Micropower Undervoltage Sensing Circuits with Programmable Output Delay

The MC33465 series are micropower undervoltage sensing circuits that are specifically designed for use with battery powered microprocessor based systems, where extended battery life is required. A choice of several threshold voltages from 0.9 V to 4.5 V are available. This device features a very low quiescent bias current of 1.0 μ A typical.

The MC33465 series features a highly accurate voltage reference, a comparator with precise thresholds and built-in hysteresis to prevent erratic reset operation, a choice of output configurations between open drain or complementary, a time delayed output, which can be programmed by the system designer, and guaranteed operation below 1.0 V with extremely low standby current. This device is available in a SOT-23 5-pin surface mount package.

Applications include direct monitoring of the MPU/logic power supply used in appliance, automotive, industrial and portable equipment.

Features:

- Extremely Low Standby Current of 1.0 μ A at $V_{in} = 3.5$ V
- Wide Input Voltage Range (0.7 V to 10 V)
- Monitors Power Supply Voltages from 1.1 V to 5.0 V
- High Accuracy Detector Threshold ($\pm 2.5\%$)
- Two $\overline{\text{Reset}}$ Output Types (Open Drain or Complementary Drive)
- Programmable Output Delay by External Capacitor (100 ms typ. with 0.15 μ F)
- Surface Mount Package (SOT-23 5-Pin)
- Convenient Tape and Reel (3000 per Reel)

Representative Block Diagrams

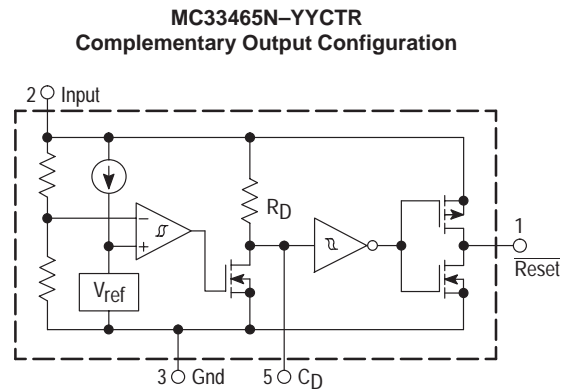
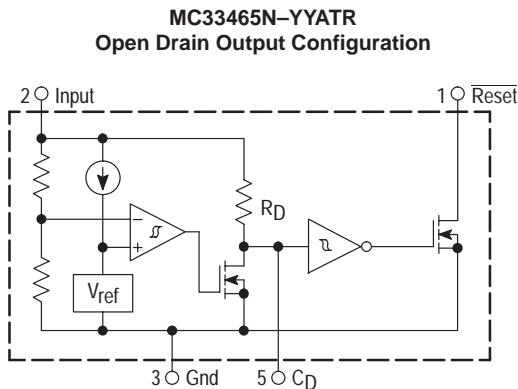

YY Denotes Threshold Voltage

This device contains 28 active transistors.



ON Semiconductor
Formerly a Division of Motorola
<http://onsemi.com>

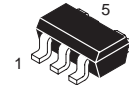

SOT-23-5
N SUFFIX
CASE 1212

PIN CONNECTIONS

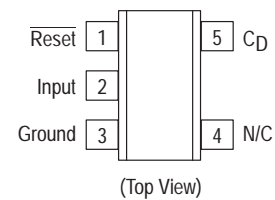

ORDERING INFORMATION

See detailed ordering and shipping information in the package dimensions section on page 7 of this data sheet.

MC33465

MAXIMUM RATINGS

| Rating | Symbol | Value | Unit |
|--|-----------------|-----------------------------|--------------------|
| Power Input Supply Voltage | V_{in} | 0 to 12 | V |
| Reset Output Voltage | V_O | -0.3 to 12 | V |
| Reset Output Current (Source or Sink) | I_O | 70 | mA |
| Power Dissipation and Thermal Characteristics | | | |
| Maximum Power Dissipation at $T_A = 25^\circ\text{C}$ | P_D | 150 | mW |
| Case 1212 (SOT-23) N Suffix Thermal Resistance, Junction-to-Ambient | $R_{\theta JA}$ | 667 | $^\circ\text{C/W}$ |
| Operating Junction Temperature | T_J | +125 | $^\circ\text{C}$ |
| Operating Ambient Temperature | T_A | -40 to +85 | $^\circ\text{C}$ |
| Storage Temperature Range | T_{stg} | -40 to +125 | $^\circ\text{C}$ |
| Lead Temperature (Soldering) | T_{solder} | 260 $^\circ\text{C}$, 10 s | |

MC33465

ELECTRICAL CHARACTERISTICS (For all values $T_A = 25^\circ\text{C}$ (Note 1), unless otherwise noted.)

| Characteristic | Symbol | Min | Typ | Max | Unit |
|---|----------------------|---------------------|------------------------|-----------------|-----------------------|
| SENSE COMPARATOR | | | | | |
| Threshold Voltage High to Low State Output (V_{in} Decreasing) | V_{IL} | | | | V |
| 09 Suffix | | 0.878 | 0.9 | 0.922 | |
| 20 Suffix | | 1.950 | 2.0 | 2.050 | |
| 22 Suffix | | 2.145 | 2.2 | 2.255 | |
| 27 Suffix | | 2.633 | 2.7 | 2.767 | |
| 28 Suffix | | 2.730 | 2.8 | 2.870 | |
| 30 Suffix | | 2.925 | 3.0 | 3.075 | |
| 32 Suffix | | 3.120 | 3.2 | 3.280 | |
| 34 Suffix | | 3.315 | 3.4 | 3.485 | |
| 38 Suffix | | 3.705 | 3.8 | 3.895 | |
| 43 Suffix | | 4.193 | 4.3 | 4.407 | |
| 44 Suffix | | 4.290 | 4.4 | 4.510 | |
| 45 Suffix | | 4.387 | 4.5 | 4.612 | |
| 46 Suffix | | 4.485 | 4.6 | 4.715 | |
| 47 Suffix | 4.583 | 4.7 | 4.817 | | |
| Threshold Hysteresis (V_{in} Increasing) | V_H | | | | V |
| 09 Suffix | | 0.027 | 0.045 | 0.063 | |
| 20 Suffix | | 0.060 | 0.100 | 0.140 | |
| 22 Suffix | | 0.066 | 0.110 | 0.154 | |
| 27 Suffix | | 0.081 | 0.135 | 0.189 | |
| 28 Suffix | | 0.084 | 0.140 | 0.196 | |
| 30 Suffix | | 0.090 | 0.150 | 0.210 | |
| 32 Suffix | | 0.096 | 0.160 | 0.224 | |
| 34 Suffix | | 0.102 | 0.170 | 0.238 | |
| 38 Suffix | | 0.114 | 0.190 | 0.266 | |
| 43 Suffix | | 0.129 | 0.215 | 0.301 | |
| 44 Suffix | | 0.132 | 0.220 | 0.308 | |
| 45 Suffix | | 0.135 | 0.225 | 0.315 | |
| 46 Suffix | | 0.138 | 0.230 | 0.322 | |
| 47 Suffix | 0.141 | 0.235 | 0.329 | | |
| Threshold Voltage Temperature Coefficient | T_C | – | ± 100 | – | PPM/ $^\circ\text{C}$ |
| RESET OUTPUT | | | | | |
| Output Voltage High State (Complementary Output: $I_{\text{source}} = 1.0 \text{ mA}$) Low State (Complementary or Open Drain Output: $I_{\text{sink}} = 1.0 \text{ mA}$) | V_{OH} V_{OL} | $V_{in} - 2.1$ – | $V_{in} - 1.0$ 0.25 | V_{in} 0.5 | V |
| Output Sink Current ($V_{in} = 1.5 \text{ V}$, $V_{OL} = 0.5 \text{ V}$) | I_{OL} | 1.0 | 2.0 | – | |
| Output Source Current ($V_{in} = 4.5 \text{ V}$, $V_{OH} = 2.4 \text{ V}$) | I_{OH} | 1.0 | 2.0 | – | mA |
| DELAY OUTPUT | | | | | |
| Output Sink Current ($V_{in} = 1.5 \text{ V}$, $V_{OL} = 0.5 \text{ V}$) | I_{OL} | 0.2 | 0.8 | – | mA |
| Delay Resistance | R_D | 0.5 | 1.0 | 2.0 | $M\Omega$ |
| TOTAL DEVICE | | | | | |
| Operating Input Voltage Range | V_{in} | 0.8 to 10 | – | – | V |
| Quiescent Input Current $V_{in} = 4.34 \text{ V}$ $V_{in} = 6.50 \text{ V}$ | I_{in} | – – | 5.5 1.3 | 11 3.9 | μA |

NOTE: 1. Low duty pulse techniques are used during test to maintain junction temperature as close to ambient as possible.

Figure 1. Reset Low State Sink Current versus Output Voltage

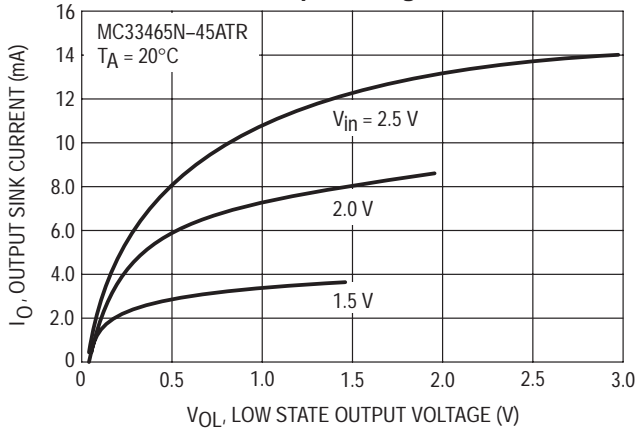

Figure 2. Output Voltage versus Input Voltage

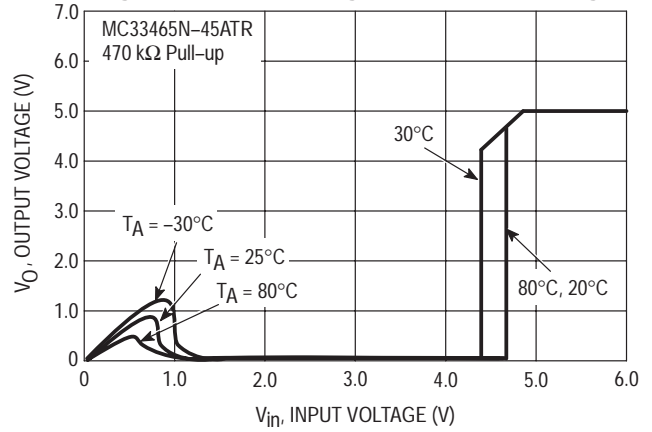

Figure 3. Input Current versus Input Voltage

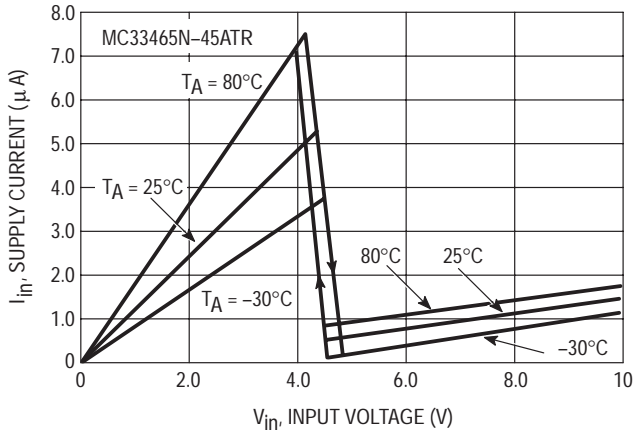

Figure 4. Comparator Input Threshold Voltage versus Temperature

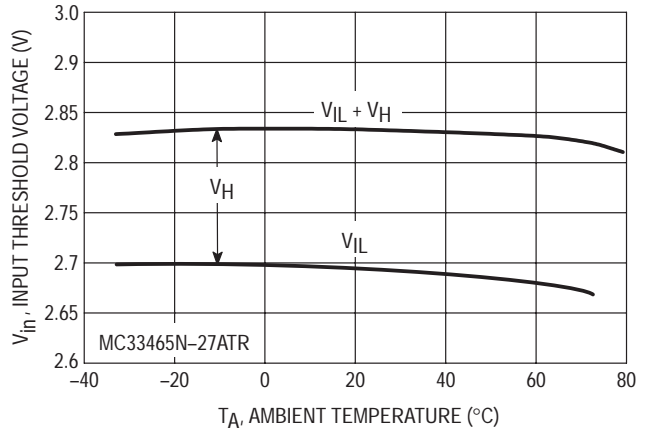

Figure 5. Reset Output Sink Current versus Input Voltage

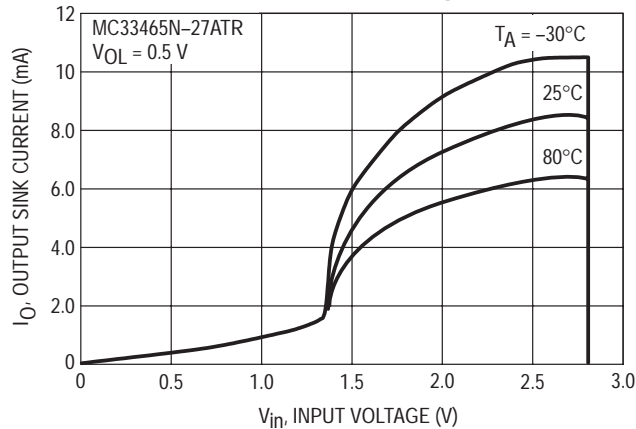
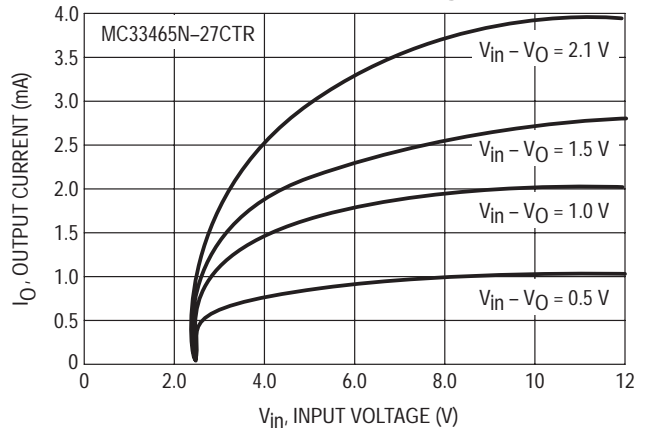

Figure 6. Reset Output Source Current versus Input Voltage



MC33465

Figure 7. C_D Sink Current versus Input Voltage

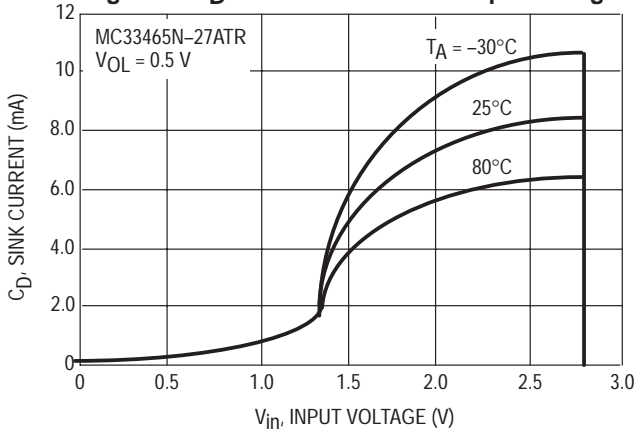

Figure 8. C_D Sink Current versus C_D Voltage

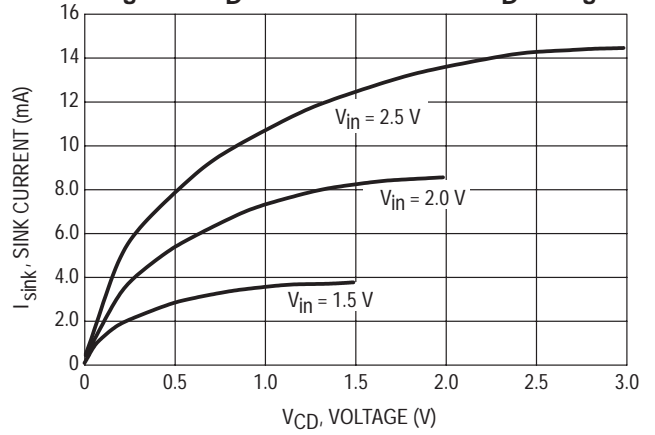

Figure 9. Delay Resistance versus Temperature

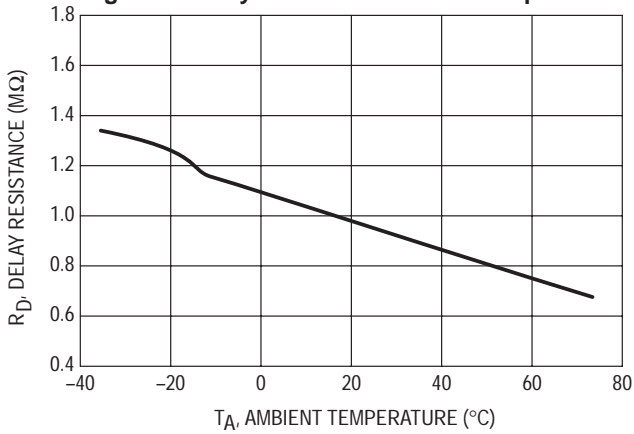

Figure 10. Detector Threshold versus Temperature

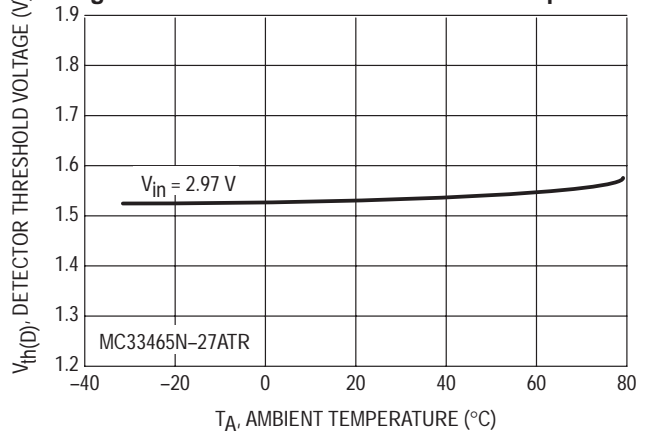
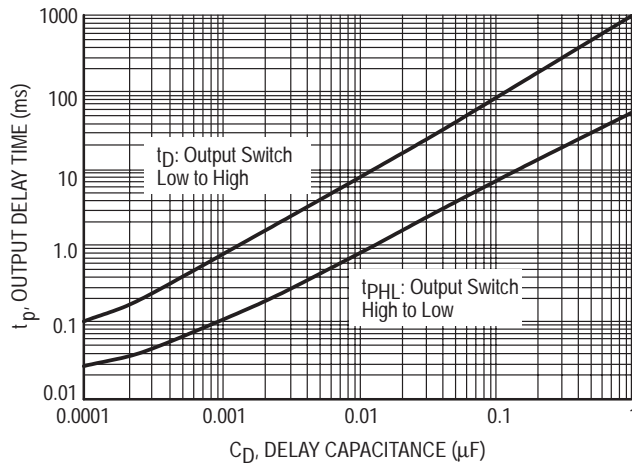

Figure 11. Output Delay Time versus Delay Capacitance



MC33465

Figure 12. Typical Open Drain Application

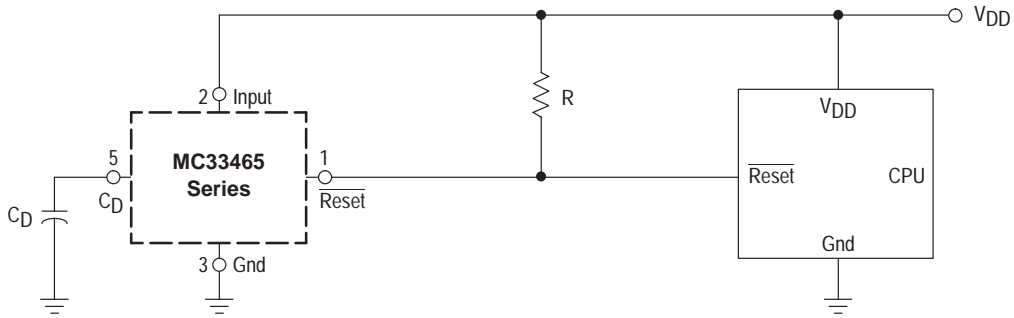
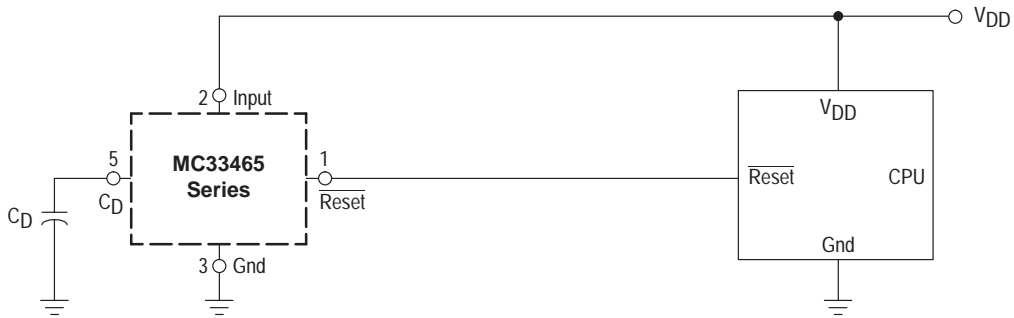

Figure 13. Typical Complementary Output Application



APPLICATION CIRCUIT INFORMATION

The MC33465 series are micropower undervoltage sensing circuits which offer a programmable time delayed output with the choice of either complementary output drive or open drain output configurations. Figure 14 shows the timing relationships between the input voltage and the resulting circuit waveforms. When the input voltage (V_{in}) exceeds the sense comparator threshold, the timing capacitor is allowed to charge through the internal delay resistor. When the output inverting driver threshold is exceeded, the Reset output switches from a logic "0" to a

logic "1". The top curve of Figure 11 provides the nominal delay time for a given value of delay capacitance. When V_{in} drops below the comparator threshold minus hysteresis voltage, the delay capacitor discharges. When the capacitance voltage drops below the inverting driver threshold, the output switches from a logic "1" to a logic "0". The bottom curve in Figure 11 provides typical delay time for given delay capacitance values. The inverting driver threshold voltage is typically about $V_{in}/2$, as shown in Figure 10.

MC33465

Figure 14. Timing Waveforms

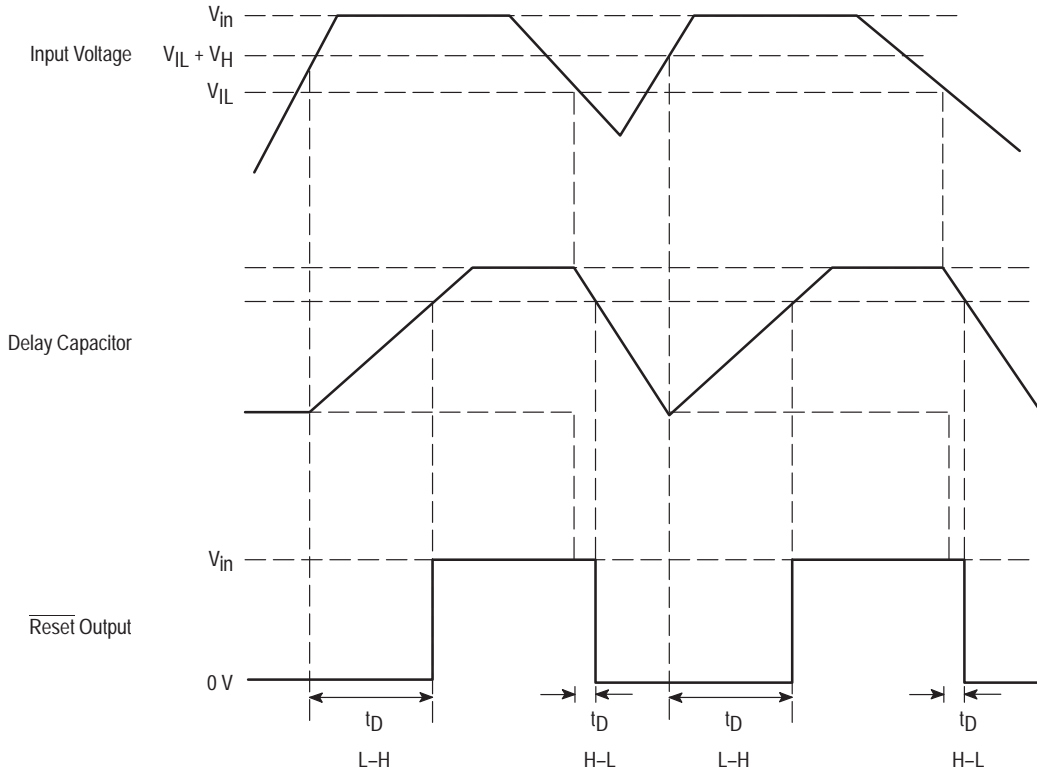

ORDERING INFORMATION

| Device | Threshold Voltage | Type | Marking | Package | Package |
|----------------|-------------------|------------------------|------------|------------------|------------------|
| MC33465N-09ATR | 0.9 | Open Drain Reset | $\bar{A}9$ | SOT-23 5-Lead | 3000 Tape & Reel |
| MC33465N-20ATR | 2.0 | | $\bar{C}0$ | | |
| MC33465N-22ATR | 2.2 | | $\bar{C}2$ | | |
| MC33465N-27ATR | 2.7 | | $\bar{C}7$ | | |
| MC33465N-28ATR | 2.8 | | $\bar{D}8$ | | |
| MC33465N-30ATR | 3.0 | | $\bar{D}0$ | | |
| MC33465N-32ATR | 3.2 | | $\bar{D}2$ | | |
| MC33465N-34ATR | 3.4 | | $\bar{D}4$ | | |
| MC33465N-38ATR | 3.8 | | $\bar{D}8$ | | |
| MC33465N-45ATR | 4.5 | | $\bar{E}5$ | | |
| MC33465N-46ATR | 4.6 | $\bar{E}6$ | | | |
| MC33465N-47ATR | 4.7 | $\bar{E}7$ | | | |
| MC33465N-09CTR | 0.9 | Compl. MOS Reset | $9\bar{A}$ | | |
| MC33465N-20CTR | 2.0 | | $0\bar{C}$ | | |
| MC33465N-27CTR | 2.7 | | $7\bar{C}$ | | |
| MC33465N-30CTR | 3.0 | | $0\bar{D}$ | | |
| MC33465N-43CTR | 4.3 | | $3\bar{E}$ | | |
| MC33465N-44CTR | 4.4 | | $4\bar{E}$ | | |
| MC33465N-45CTR | 4.5 | $5\bar{E}$ | | | |

Other voltages from 0.9 to 6.0 V, in 0.1 V increments, are available. Consult factory for information.

MC33465

PACKAGE DIMENSIONS

(SOT-23)
N SUFFIX
PLASTIC PACKAGE
CASE 1212-01
ISSUE O

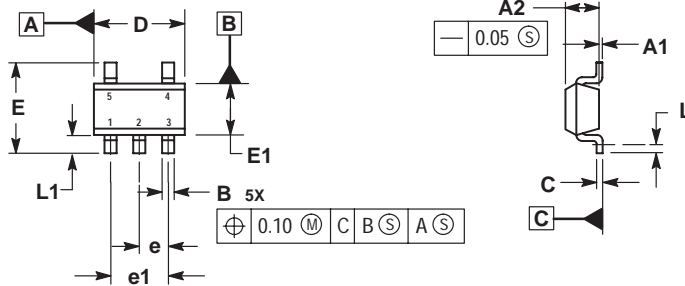

NOTES:

1. DIMENSIONS ARE IN MILLIMETERS.
2. INTERPRET DIMENSIONS AND TOLERANCES PER ASME Y14.5M, 1994.
3. DATUM C IS A SEATING PLANE.

| MILLIMETERS | | |
|-------------|----------|------|
| DIM | MIN | MAX |
| A1 | 0.00 | 0.10 |
| A2 | 1.00 | 1.30 |
| B | 0.30 | 0.50 |
| C | 0.10 | 0.25 |
| D | 2.80 | 3.00 |
| E | 2.50 | 3.10 |
| E1 | 1.50 | 1.80 |
| e | 0.95 BSC | |
| e1 | 1.90 BSC | |
| L | 0.20 | --- |
| L1 | 0.45 | 0.75 |

Recommended Footprint for Surface Mount Applications

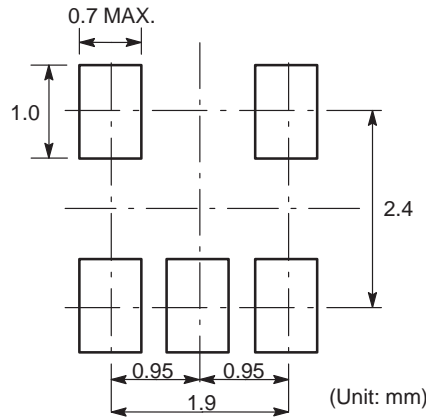

SOT-23-5

ON Semiconductor and are trademarks of Semiconductor Components Industries, LLC (SCILLC). SCILLC reserves the right to make changes without further notice to any products herein. SCILLC makes no warranty, representation or guarantee regarding the suitability of its products for any particular purpose, nor does SCILLC assume any liability arising out of the application or use of any product or circuit, and specifically disclaims any and all liability, including without limitation special, consequential or incidental damages. "Typical" parameters which may be provided in SCILLC data sheets and/or specifications can and do vary in different applications and actual performance may vary over time. All operating parameters, including "Typicals" must be validated for each customer application by customer's technical experts. SCILLC does not convey any license under its patent rights nor the rights of others. SCILLC products are not designed, intended, or authorized for use as components in systems intended for surgical implant into the body, or other applications intended to support or sustain life, or for any other application in which the failure of the SCILLC product could create a situation where personal injury or death may occur. Should Buyer purchase or use SCILLC products for any such unintended or unauthorized application, Buyer shall indemnify and hold SCILLC and its officers, employees, subsidiaries, affiliates, and distributors harmless against all claims, costs, damages, and expenses, and reasonable attorney fees arising out of, directly or indirectly, any claim of personal injury or death associated with such unintended or unauthorized use, even if such claim alleges that SCILLC was negligent regarding the design or manufacture of the part. SCILLC is an Equal Opportunity/Affirmative Action Employer.

PUBLICATION ORDERING INFORMATION

USA/EUROPE Literature Fulfillment:
Literature Distribution Center for ON Semiconductor
P.O. Box 5163, Denver, Colorado 80217 USA
Phone: 303-675-2175 or 800-344-3860 Toll Free USA/Canada
Fax: 303-675-2176 or 800-344-3867 Toll Free USA/Canada
Email: ONlit@hibbertco.com

Fax Response Line*: 303-675-2167
800-344-3810 Toll Free USA/Canada
*To receive a Fax of our publications

N. America Technical Support: 800-282-9855 Toll Free USA/Canada

ASIA/PACIFIC: LDC for ON Semiconductor – Asia Support
Phone: 303-675-2121 (Tue-Fri 9:00am to 1:00pm, Hong Kong Time)
Email: ONlit-asia@hibbertco.com

JAPAN: ON Semiconductor, Japan Customer Focus Center
4-32-1 Nishi-Gotanda, Shinagawa-ku, Tokyo, Japan 141-8549
Phone: 81-3-5487-8345
Email: r14153@onsemi.com

ON Semiconductor Website: <http://onsemi.com>

For additional information, please contact your local Sales Representative.